







BEYNAC

BEYNAC LAITON

Poignée/plaque 195 Laiton Poli verni

BDC	Bec de cane	010401LP
	Clé	010402LP
	Cylindre	010403LP
	Condamnation	010404LP

Vieux Laiton

BDC	Bec de cane	010401VL
	Clé	010402VL
	Cylindre	010403VL
	Condamnation	010404VL

Béquille double Beynac

 Laiton Poli verni 010407LP

 Vieux Laiton 010407VL

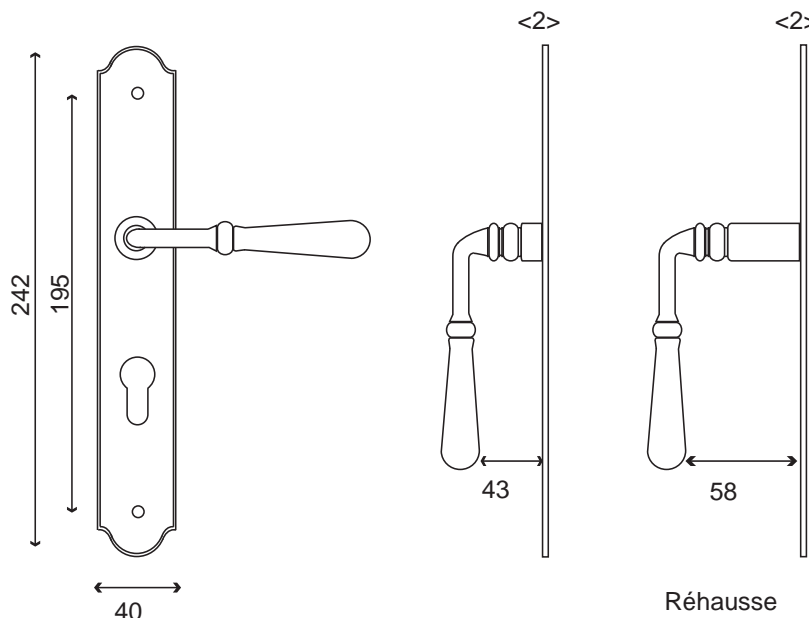

- Béquille sans ressort de rappel sur grande plaque fine de 2mm d'épaisseur ou sans plaque
- Carré de 7mm et visserie fournis pour portes de 40mm d'épaisseur

BEYNAC LAITON





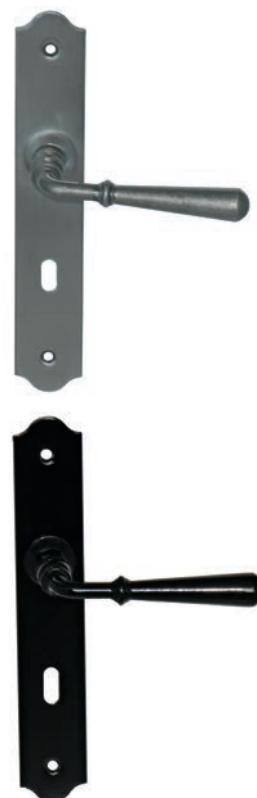

BEYNAC FER





BEYNAC FER

Poignée/plaque 195 Fer Patiné

BDC	Bec de cane	010401FP
	Clé	010402FP
	Cylindre	010403FP
	Condamnation	010404FP

 Cylindre Réhausse 010403RFP

Noir

BDC	Bec de cane	010401N
	Clé	010402N
	Cylindre	010403N
	Condamnation	010404N

 Cylindre Réhausse 010403RN